

Transient Voltage Suppressors (TVS) Data Sheet

Features

- For surface mounted applications in order to optimize board space
- Low profile package
- Built-in strain relief
- Glass passivated junction
- Low inductance
- Excellent clamping capability
- 1000W peak pulse power capability at 10/1000μs waveform, repetition rate (duty cycle): 0.01%
- Fast response time
- Typical I_R less than 1μA above 12V
- High Temperature soldering: 260°C/10 seconds at terminals
- Plastic package has underwriters laboratory flammability 94V-0
- Meets MSL level 1, per J-STD-020



Mechanical Data

- Case: JEDEC DO-214AA. Molded plastic over glass passivated junction
- Terminal: Solder plated, solderable per MIL-STD-750, Method 2026
- Polarity: Color band denotes cathode except bi-directional models
- Standard Packaging: 12mm tape (EIA STD RS-481)
- Weight: 0.10g

Applications

- I/O interface
- AC/DC power supply
- Low frequency signal transmission line (RS232, RS485, etc.)

Maximum Ratings and Characteristics

Ratings at 25°C ambient temperature unless otherwise specified.

Rating	Symbol	Value	Units
Peak pulse power dissipation at 10/1000μs waveform (Note1, Note2, Fig.1)	P_{PPM}	Minimum 1000	Watts
Peak pulse current of at 10/1000μs waveform (Note 1, Fig.3)	I_{PPM}	See Table	Amps
Steady state power dissipation at $T_A=50^\circ\text{C}$ (Fig.5)	$P_{M(AV)}$	5.0	Watts
Peak forward surge current, 8.3ms single half sine-wave superimposed on rated load, (JEDEC Method) (Note3, Fig.6)	I_{FSM}	100	Amps
Operating junction and Storage Temperature Range.	T_J, T_{STG}	-65 to +150	°C
Typical thermal resistance junction to lead	$R_{\theta JL}$	20	°C/W
Typical thermal resistance junction to ambient	$R_{\theta JA}$	100	°C/W

Notes: 1. Non-repetitive current pulse, per Fig.3 and derated above $T_A=25^\circ\text{C}$ per Fig.2.

2. Mounted on 5.0mm×5.0mm (0.03mm thick) copper pads to each terminal.

3. 8.3ms single half sine-wave, or equivalent square wave, duty cycle=4 pulses per minutes maximum.

Dimensions (SMB/DO-214AA)

	Symbol	Millimeters		Inches	
		Min.	Max.	Min.	Max.
	L	4.06	4.57	0.160	0.180
	D	3.30	3.94	0.130	0.155
	D1	1.95	2.20	0.077	0.086
	T	5.21	5.59	0.205	0.220
	T1	0.76	1.52	0.030	0.060
	d	-	0.203	-	0.008
	H	2.15	2.65	0.085	0.104
	H1	2.13	2.47	0.084	0.097

Electrical Characteristics ($T_A=25^\circ\text{C}$)

Part Number		Device Marking Code		Reverse Stand-Off Voltage	Breakdown Voltage @ I_T	Test Current	Maximum Clamping Voltage @ I_{PP}	Peak Pulse Current	Reverse Leakage @ V_{RWM}
Unidirectional	Bidirectional	UNI	BI	$V_{RWM}(V)$	$V_{BR}(V)$	$I_T(mA)$	$V_C(V)$	$I_{PP}(A)$	$I_R(\mu A)$
1.0SMB6.8A	1.0SMB6.8CA	6K8A	6K8C	5.80	6.45~7.14	10	10.5	96.8	1000
1.0SMB7.5A	1.0SMB7.5CA	7K5A	7K5C	6.40	7.13~7.88	10	11.3	90.0	500
1.0SMB8.2A	1.0SMB8.2CA	8K2A	8K2C	7.02	7.79~8.61	10	12.1	84.0	200
1.0SMB9.1A	1.0SMB9.1CA	9K1A	9K1C	7.78	8.65~9.55	1	13.4	75.8	50
1.0SMB10A	1.0SMB10CA	K10A	K10C	8.55	9.50~10.50	1	14.5	70.2	10
1.0SMB11A	1.0SMB11CA	K11A	K11C	9.40	10.50~11.60	1	15.6	65.2	5
1.0SMB12A	1.0SMB12CA	K12A	K12C	10.20	11.40~12.60	1	16.7	60.8	5
1.0SMB13A	1.0SMB13CA	K13A	K13C	11.10	12.40~13.70	1	18.2	55.8	1
1.0SMB15A	1.0SMB15CA	K15A	K15C	12.80	14.30~15.80	1	21.2	48.0	1
1.0SMB16A	1.0SMB16CA	K16A	K16C	13.60	15.20~16.80	1	22.5	45.2	1
1.0SMB18A	1.0SMB18CA	K18A	K18C	15.30	17.10~18.90	1	25.5	40.3	1
1.0SMB20A	1.0SMB20CA	K20A	K20C	17.10	19.00~21.00	1	27.7	36.7	1
1.0SMB22A	1.0SMB22CA	K22A	K22C	18.80	20.90~23.10	1	30.6	33.2	1
1.0SMB24A	1.0SMB24CA	K24A	K24C	20.50	22.80~25.20	1	33.2	30.7	1

Electrical Characteristics ($T_A=25^{\circ}\text{C}$)

Part Number		Device Marking Code		Reverse Stand-Off Voltage	Breakdown Voltage @ I_T	Test Current	Maximum Clamping Voltage @ I_{PP}	Peak Pulse Current	Reverse Leakage @ V_{RWM}
Unidirectional	Bidirectional	UNI	BI	$V_{RWM}(V)$	$V_{BR}(V)$	$I_T(mA)$	$V_C(V)$	$I_{PP}(A)$	$I_R(\mu A)$
1.0SMB27A	1.0SMB27CA	K27A	K27C	23.10	25.70~28.40	1	37.5	27.2	1
1.0SMB30A	1.0SMB30CA	K30A	K30C	25.60	28.50~31.50	1	41.4	24.5	1
1.0SMB33A	1.0SMB33CA	K33A	K33C	28.20	31.40~34.70	1	45.7	22.2	1
1.0SMB36A	1.0SMB36CA	K36A	K36C	30.80	34.20~37.80	1	49.9	20.3	1
1.0SMB39A	1.0SMB39CA	K39A	K39C	33.30	37.10~41.00	1	53.9	18.8	1
1.0SMB43A	1.0SMB43CA	K43A	K43C	36.80	40.90~45.20	1	59.3	17.2	1
1.0SMB47A	1.0SMB47CA	K47A	K47C	40.20	44.70~49.40	1	64.8	15.7	1
1.0SMB51A	1.0SMB51CA	K51A	K51C	43.60	48.50~53.60	1	70.1	14.5	1
1.0SMB56A	1.0SMB56CA	K56A	K56C	47.80	53.20~58.80	1	77.0	13.2	1
1.0SMB62A	1.0SMB62CA	K62A	K62C	53.00	58.90~65.10	1	85.0	12.0	1
1.0SMB68A	1.0SMB68CA	K68A	K68C	58.10	64.60~71.40	1	92.0	11.0	1

Notes: For bidirectional type having V_{RWM} of 12V and less, the I_R limit is double.

Ratings and Characteristic Curves ($T_A=25^\circ\text{C}$ unless otherwise noted)

Figure 1. Peak Pulse Power Rating Curve

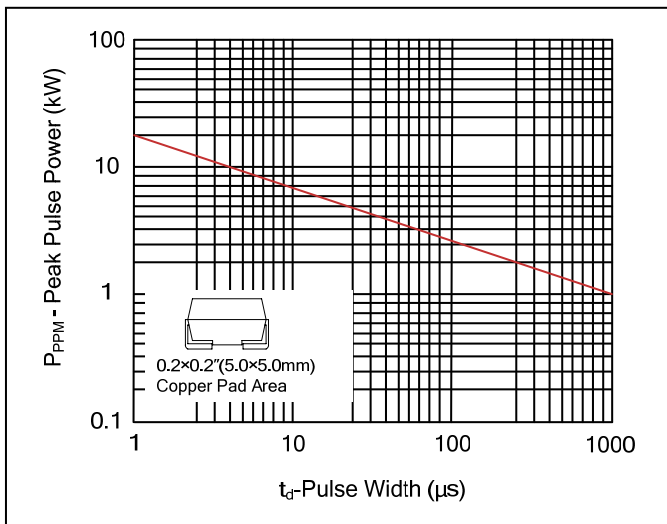

Figure 2. Pulse Derating Curve

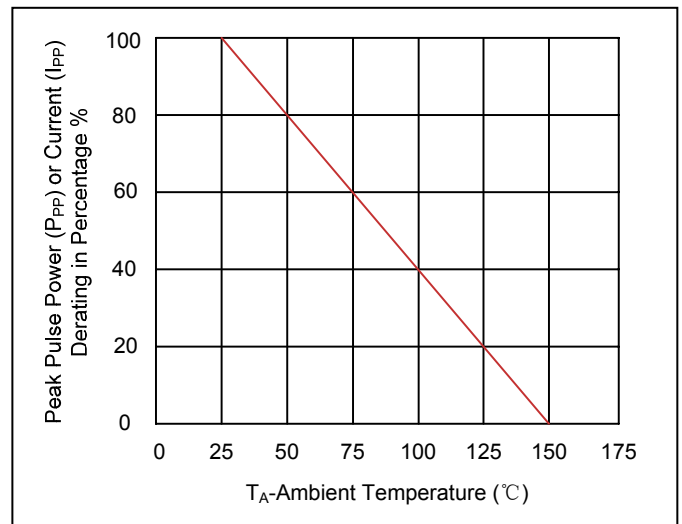

Figure 3. Pulse Waveform

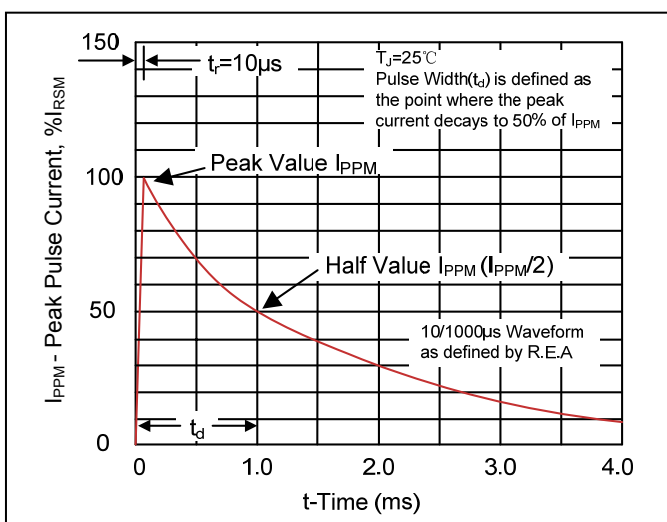

Figure 4. Typical Junction Capacitance

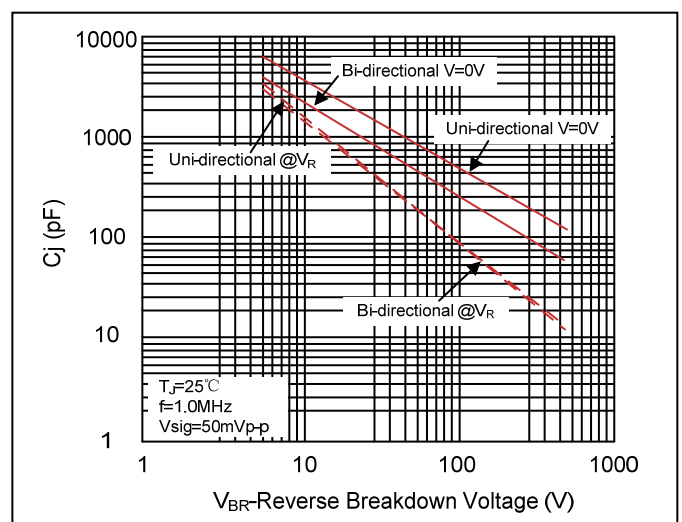

Figure 5. Steady State Power Dissipation Derating Curve

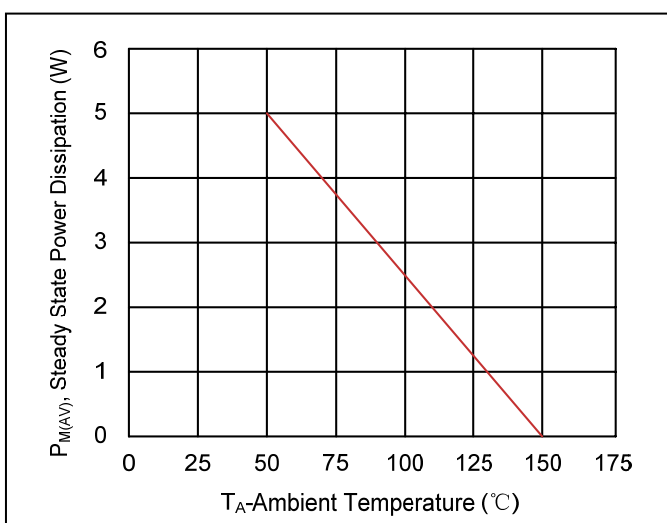
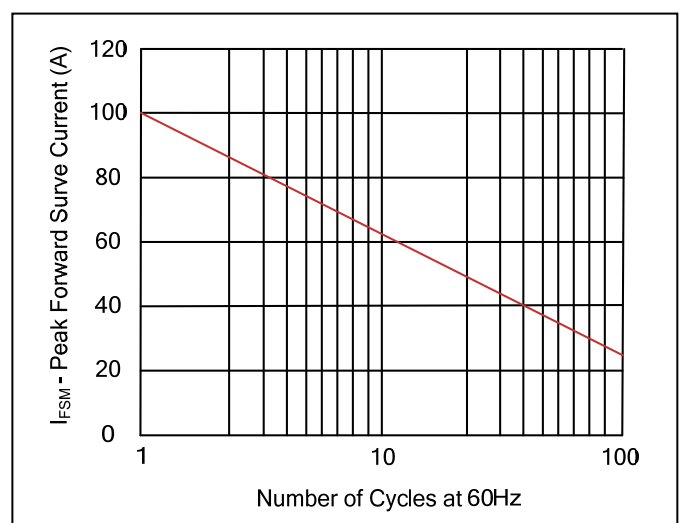
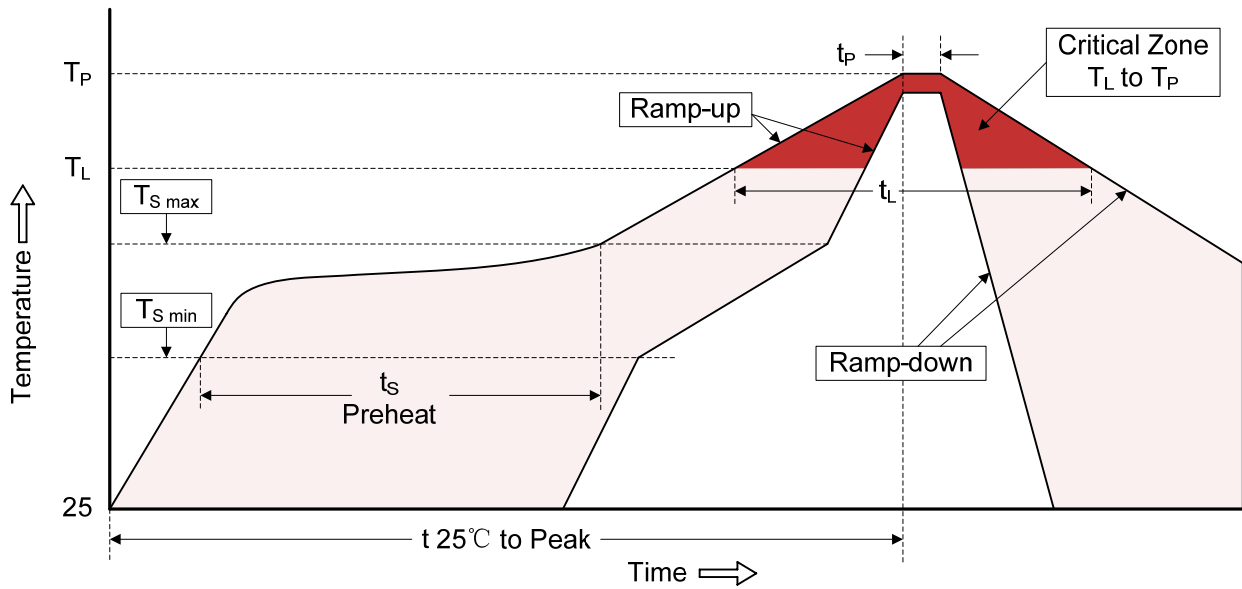

Figure 6. Maximum Non-Repetitive Forward Surge Current Uni-Directional Only



Recommended Soldering Conditions

Reflow Soldering



Recommended Conditions

Profile Feature	Pb-Free Assembly
Average ramp-up rate (T_L to T_P)	3°C/second max.
Preheat -Temperature Min ($T_{S\ min}$) -Temperature Max ($T_{S\ max}$) -Time (min to max) (t_s)	150°C 200°C 60-180 seconds
$T_{S\ max}$ to T_L -Ramp-up Rate	3°C/second max.
Time maintained above: -Temperature (T_L) -Time (t_L)	217°C 60-150 seconds
Peak Temperature (T_P)	260°C
Time within 5°C of actual Peak Temperature (t_p)	20-40 seconds
Ramp-down Rate	6°C/second max.
Time 25°C to Peak Temperature	8 minutes max.

Marking Code

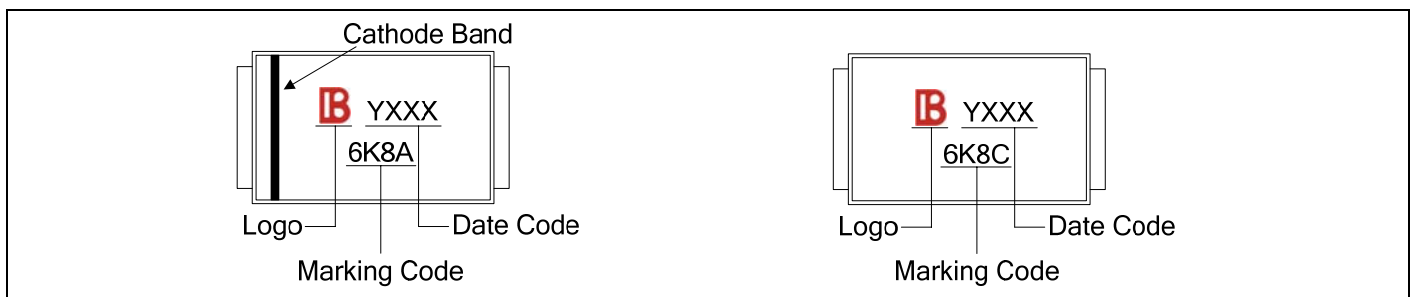

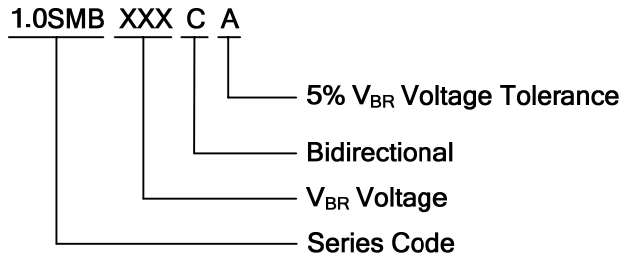

Packaging

Tape	Symbol	Dimension (mm)	
	W	12.00±0.20	
	P0	4.00±0.10	
	P1	8.00±0.10	
	P2	2.00±0.10	
	D0	Φ1.55±0.10	
	D1	Φ1.5±0.10	
	E	1.75±0.10	
	F	5.50±0.10	
	A0	3.86±0.15	
	B0	5.65±0.10	
	K0	2.75±0.15	
	T	0.25±0.05	
	<p>7" Reel</p>	D2	Φ178.0±2.0
		D3	Φ50.0Min.
D4		Φ13.0±0.5	
W1		16.0±2.0	
Quantity: 500PCS			
<p>13" Reel</p>	D5	Φ330.0±2.0	
	D6	Φ13.5±0.5	
	H	2.5±1.0	
	W2	16.0±2.0	
	Quantity: 3000PCS		