

InGaAs PIN photodiode

G6854-01

Spherical lens window package for efficient fiber coupling



Features

- Easy optical axis alignment
- High fiber coupling efficiency
- CD package
High degree of base positioning accuracy allows easy positioning.
- Package weldable by YAG laser
- Spherical lens window with AR coating minimizes return light input

Applications

- Optical fiber communications

■ Absolute maximum ratings (Ta=25 °C)

Parameter	Symbol	Value	Unit
Reverse voltage	V _R Max.	20	V
Operating temperature	T _{opr}	-40 to +85	°C
Storage temperature	T _{stg}	-55 to +125	°C

■ Electrical and optical characteristics (Ta=25 °C)

Parameter	Symbol	Condition	Min.	Typ.	Max.	Unit
Spectral response range	λ		-	0.9 to 1.7	-	μm
Peak sensitivity wavelength	λ_p		-	1.55	-	μm
Photo sensitivity	S	$\lambda=1.3 \mu\text{m}$	0.8	0.9	-	A/W
		$\lambda=1.55 \mu\text{m}$	0.85	0.95	-	A/W
Dark current	I _D	V _R =5 V	-	80	400	pA
Cut-off frequency	f _c	V _R =5 V, R _L =50 Ω $\lambda=1.3 \mu\text{m}$, -3 dB	1	2	-	GHz
Terminal capacitance	C _t	V _R =5 V, f=1 MHz	-	1	1.5	pF
Shunt resistance	R _{sh}	V _R =10 mV	-	8	-	G Ω
Detectivity	D*	$\lambda=\lambda_p$	-	5×10^{12}	-	cm · Hz ^{1/2} /W
Noise equivalent power	NEP	$\lambda=\lambda_p$	-	2×10^{-15}	-	W/Hz ^{1/2}

G6854-01 may be damaged by Electro Static Discharge, etc. Be carefull when using G6854-01.

■ Spectral response

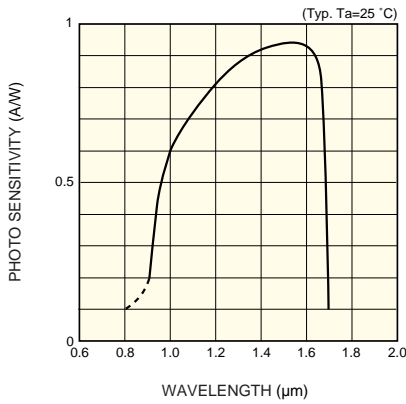

KIRDB0002EB

■ Dark current vs. reverse voltage

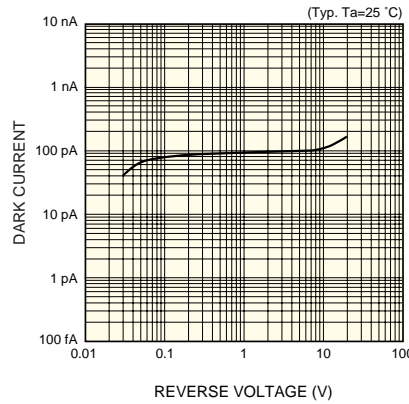

KIRDB0152EA

■ Terminal capacitance vs. reverse voltage

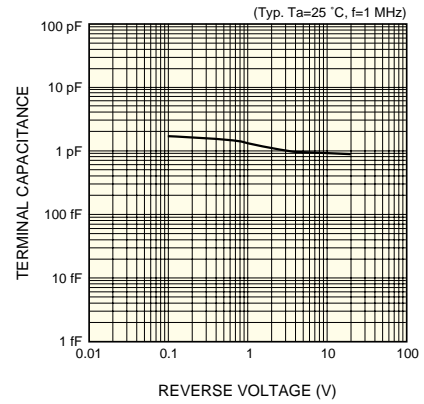

KIRDB0156EA

■ Frequency response

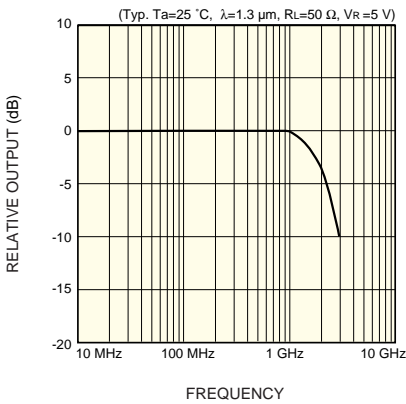

KIRDB0154EA

■ Fiber coupling characteristic (X, Y axes)

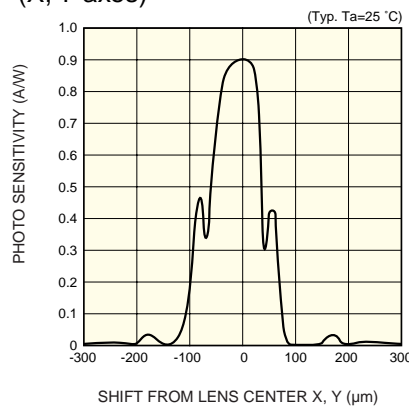

KIRDB0155EB

■ Fiber coupling characteristic (Z axis)

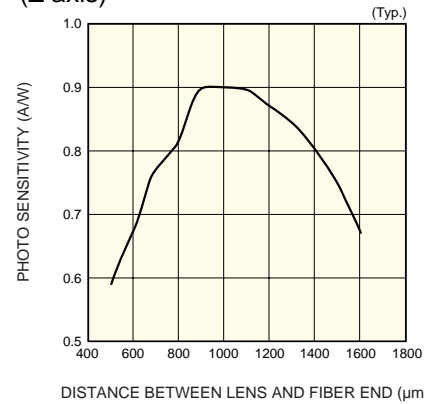

KIRDB0156EB

■ Dimensional outline (unit: mm)

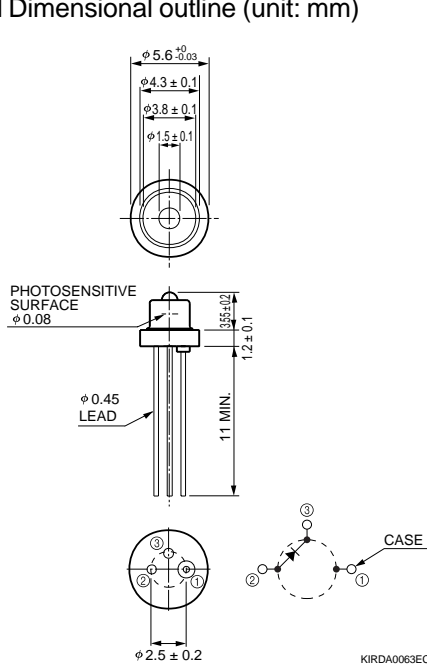

KIRDA0063EC

KIRDC0042EA

KIRDC0043EA

HAMAMATSU

Information furnished by HAMAMATSU is believed to be reliable. However, no responsibility is assumed for possible inaccuracies or omissions. Specifications are subject to change without notice. No patent rights are granted to any of the circuits described herein. ©2004 Hamamatsu Photonics K.K.

HAMAMATSU PHOTONICS K.K., Solid State Division

1126-1 Ichino-cho, Higashi-ku, Hamamatsu City, 435-8558 Japan, Telephone: (81) 53-434-3311, Fax: (81) 53-434-5184, <http://www.hamamatsu.com>

U.S.A.: Hamamatsu Corporation: 360 Foothill Road, P.O.Box 6910, Bridgewater, N.J. 08807-0910, U.S.A., Telephone: (1) 908-231-0960, Fax: (1) 908-231-1218

Germany: Hamamatsu Photonics Deutschland GmbH: Arzbergerstr. 10, D-82211 Herrsching am Ammersee, Germany, Telephone: (49) 08152-3750, Fax: (49) 08152-2658

France: Hamamatsu Photonics France S.A.R.L.: 19, Rue du Saule Trappu, Parc du Moulin de Massy, 91882 Massy Cedex, France, Telephone: 33-(1) 69 53 71 00, Fax: 33-(1) 69 53 71 10

United Kingdom: Hamamatsu Photonics UK Limited: 2 Howard Court, 10 Tewin Road, Welwyn Garden City, Hertfordshire AL7 1BW, United Kingdom, Telephone: (44) 1707-294888, Fax: (44) 1707-325777

North Europe: Hamamatsu Photonics Norden AB: Smidesvägen 12, SE-171 41 Solna, Sweden, Telephone: (46) 8-509-031-00, Fax: (46) 8-509-031-01

Italy: Hamamatsu Photonics Italia S.R.L.: Strada della Moia, 1/E, 20020 Arese, (Milano), Italy, Telephone: (39) 02-935-81-733, Fax: (39) 02-935-81-741